

D600-0.00.00.000-02

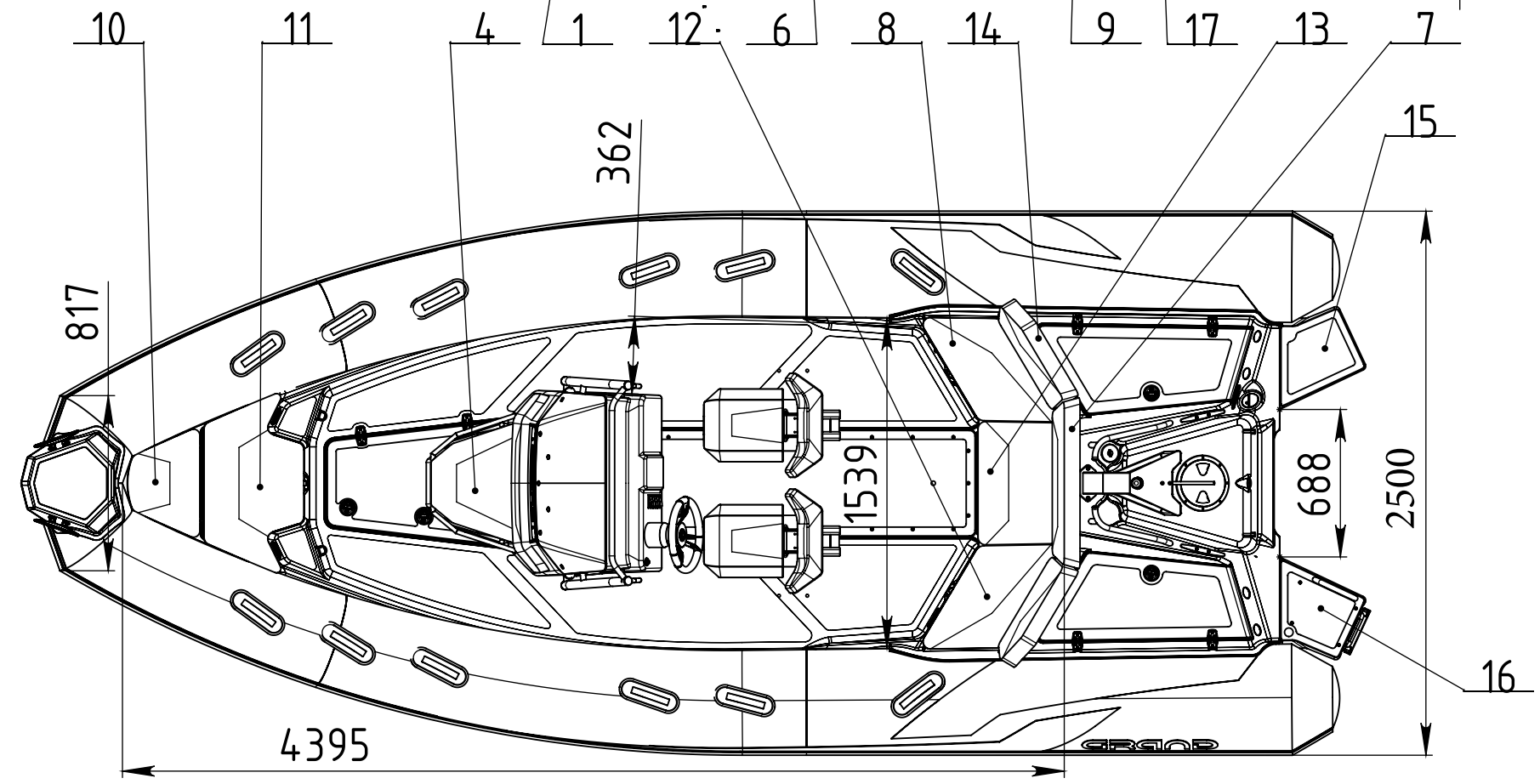
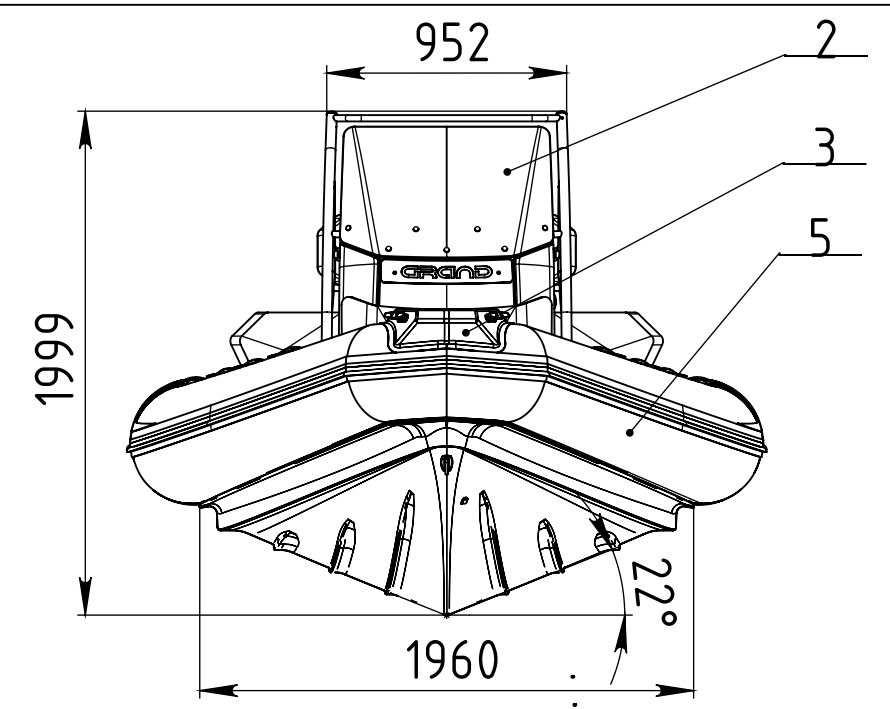
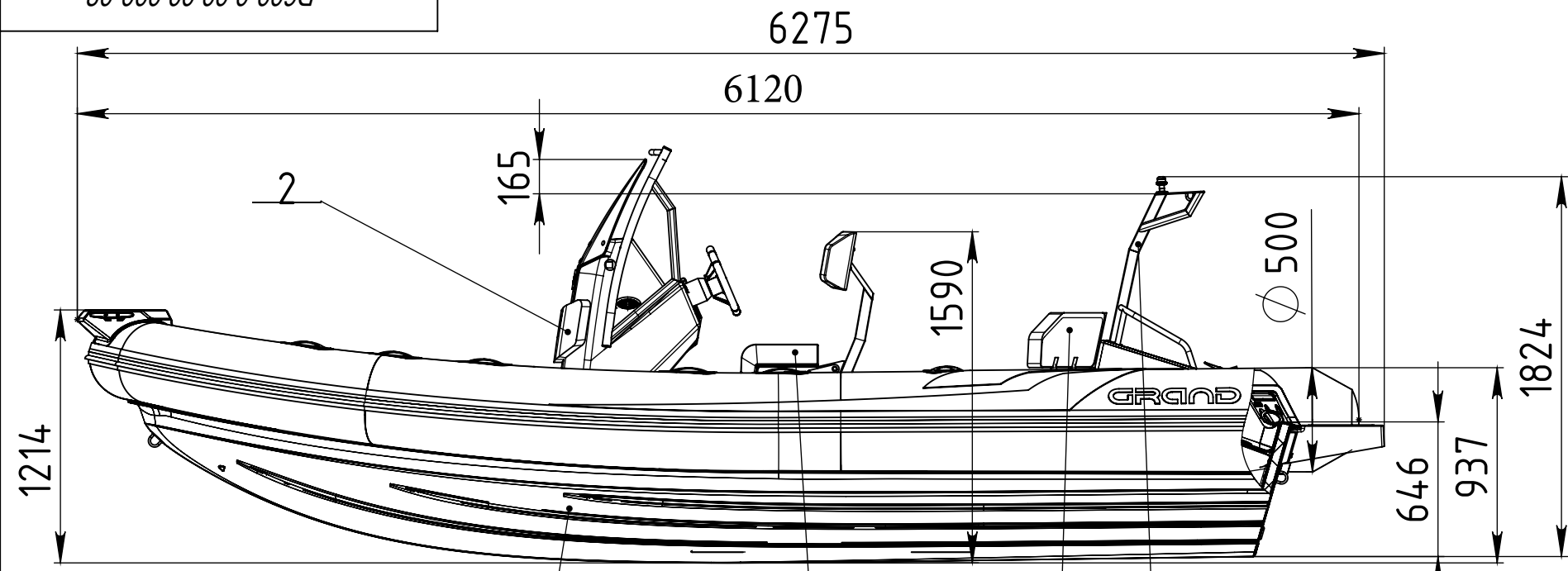

Item	Designation	Denomination	Qty.
1	26003	Fiberglass hull	1
2	42500	Steering console CL-26 (LUX/ACTIVE)	1
3	40632	Bow step plate	1
4	40670	Removable front seat SD-07	1
5	35804	Inflate tube	1
6	40640	Adjustable jockey seat SS-01	2
7	50491	Rear central backrest	1
8	50488	Rear right cushion seat	1
9	50493	Rear left backrest	1
10	50480	Anchor cushion	1
11	50481	Front seat	1
12	50493	Rear left cushion seat	1
13	50484	Rear central cushion seat	1
14	50495	Rear right backrest	1
15	40635	Right swimming platform	1
16	40638	Left swimming platform with ladder	1
17	53104	Waterski towing/navigation arch, painted	1

DIMENSION (cm)		CAPACITY		TUBE	
Length overall	612	Passengers capacity	12	Tube diameter (cm)	50
Length internal	440	Max loading capacity (kg)	1110	Number of chambers	5
Width overall	2500	Transport gross weight (kg)	706	Tube volume (m³)	2.01
Width internal	154	Bare boat weight (kg)	596	Tube material	PVC/Hypalon
Engine max (HP)	150				
Engine recommended (HP)	130				

Изм.	Лист	№ докум.	Подп.	Дата
Drawn		Miroshnichenko S		
Confirm		Borodin V		

DRIVE D600 ACTIVE		Scale	
		1:30	
16002		Лист 1	Листов 1
		Grand Marine LTD	

Подпись и дата
 Инв. № дубл.
 Взам. инв. №
 Подпись и дата
 Инв. № подл.